



KERN & Sohn GmbH

Ziegelei 1
D-72336 Balingen
E-Mail: info@kern-sohn.com

Phone: +49-[0]7433- 9933-0
Fax: +49-[0]7433-9933-149
Internet: www.kern-sohn.com

Operating manual

Multi-function weighing balance

KERN MWA-M / MWA-PM

Version 1.4
04/2016
GB



MWA-M / MWA-PM-BA-e-1614



KERN MWA 300K1M / MWA 300K1PM

Version 1.4 04/2016

Operating manual

Multi-function weighing balance

Contents

1	Technical data	4
2	Declaration of conformity	5
2.1	Explanation of the graphic symbols	5
3	Appliance overview	7
4	Keyboard overview	9
5	Overview of display	10
6	Basic instructions	11
6.1	Specific function	11
6.2	Proper use	11
6.3	Improper Use	12
6.4	Warranty	12
6.5	Monitoring of Test Resources	12
7	Basic Safety Precautions	13
7.1	Pay attention to the instructions in the Operation Manual	13
7.2	Personnel training	13
7.3	Preventing contamination	13
8	Electromagnetic compatibility (EMC)	14
8.1	General hints	14
8.2	Electromagnetic interferences	15
8.3	Electromagnetic noise immunity	16
8.3.1	Crucial features of performance	18
8.4	Minimum distances	18
9	Transport and storage	19
9.1	Testing upon acceptance	19
9.2	Packaging / return transport	19
10	Unpacking, Setup and Commissioning	20
10.1	Installation Site, Location of Use	20
10.2	Unpacking	20
10.3	Scope of delivery	21
10.4	Balance assembly and installation	21
10.4.1	Application examples:	21
10.5	Mains connection	22
10.6	Battery operation is possible by obtaining an optional battery power pack	23
10.7	Battery operation	24
10.8	Initial Commissioning	26

11	Operation	26
11.1	Weighing.....	26
11.1.1	Weighing with wheelchair.....	27
11.2	Taring	27
11.3	HOLD function	28
11.4	Display additional last decimal place.....	29
11.5	Calculation of the Body Mass Index	29
11.5.1	Calculating Body Mass Index.....	29
11.5.2	Classification of BMI values	30
11.6	Automatic switch-off function „AUTO OFF“	31
11.7	Display background illumination.....	32
12	Menu.....	33
12.1	Navigation in the menu	33
12.2	Menu overview.....	34
13	Data output RS 232	36
13.1	Pin allocation of balance output bushing:	36
13.2	Technical data	36
13.3	Printer operation	37
14	Error messages	37
15	Servicing, maintenance, disposal.....	38
15.1	Cleaning	38
15.2	Cleaning / disinfecting	38
15.3	Servicing, maintenance.....	38
15.4	Disposal.....	38
16	Instant help	39
17	Verification.....	40
17.1	Verification validity period (current status in G)	42
18	Adjustment	43

1 Technical data

KERN	MWA 300K1M	MWA 300K1PM
Display	6-digit	
Weighing range (max)	300 kg	
Minimum load (Min)	2 kg	
Verification value (e)	100 g	
Reproducibility	0.1 kg	
Linearity ±	0.1 kg	
Display	LCD with 25mm high digits	
Recommended adjustment weight, (Class)	300 kg (M1)	
Stabilization time (typical)	2 sec.	
Warm-up time	10 min	
Operating temperature	- 10° C + 40° C	
Humidity of air	max. 80 % (not condensing)	
Electric Supply	Input voltage 100V-240V AC, 50 / 60 Hz	
Auto Off	After 3, 5, 15, 30 min without load change (adjustable)	
Dimensions fully assembled (D x W X H) mm	1190 x 1140 x 80	1190 x 1140 x 1150
Weighing plate (W x D) mm	880 x 840	
Weight kg (net)	72	76
Rechargeable battery operation	Optional	
Batteries	6 x 1.5 V AA	
Data interface provided as standard	RS 232 C	

2 Declaration of conformity

To view the current EC/EU Declaration of Conformity go to:

www.kern-sohn.com/ce

- i** The scope of delivery for verified weighing balances (= conformity-rated weighing balances) includes a Declaration of Conformity. Solely these weighing balances are classified as medical devices.

2.1 Explanation of the graphic symbols

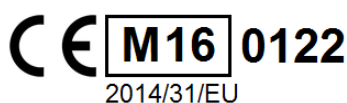

This marking indicates that these weighing balances are in conformity with EU Directive 2014/31/EU for non-automatic weighing balances. Weighing balances bearing this marking are licensed for medical purposes in the European Union.

The number inside the frame "M16" (example shown year 16) documents the year of conformity assessment.



This marking shows that this weighing balance is in conformity with EU Directive 93/42/EEC and inside the European Community is classified as medical device.

WF 150012

Designation of the serial number of every device, applied at the device and on the packaging

Number here as example



2016-03

Identification of the manufacturing date of the medical product.

Year and month here as example



"Please note the accompanying documents"
or "Please note operating instructions"



“Observe operating instructions”



“Observe operating instructions”



Identification of manufacturer of medical product including address

Kern & Sohn GmbH
D-72336 Baligen, Germany
www.kern-sohn.com



“Electro-medical appliance“
with attachment for type B

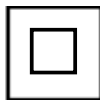

Device protection category II



Dispose of old appliances separately from your household waste!

Instead, take them to communal collection points.

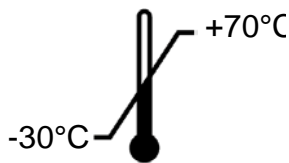

Temperature limit indicating the upper and the lower limit (storage temperature on packaging) (Temperature serving as an example)

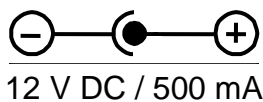

Display of supply voltage for scales with polarity display.



Safety instruction: Do not place hands beneath the ramp.





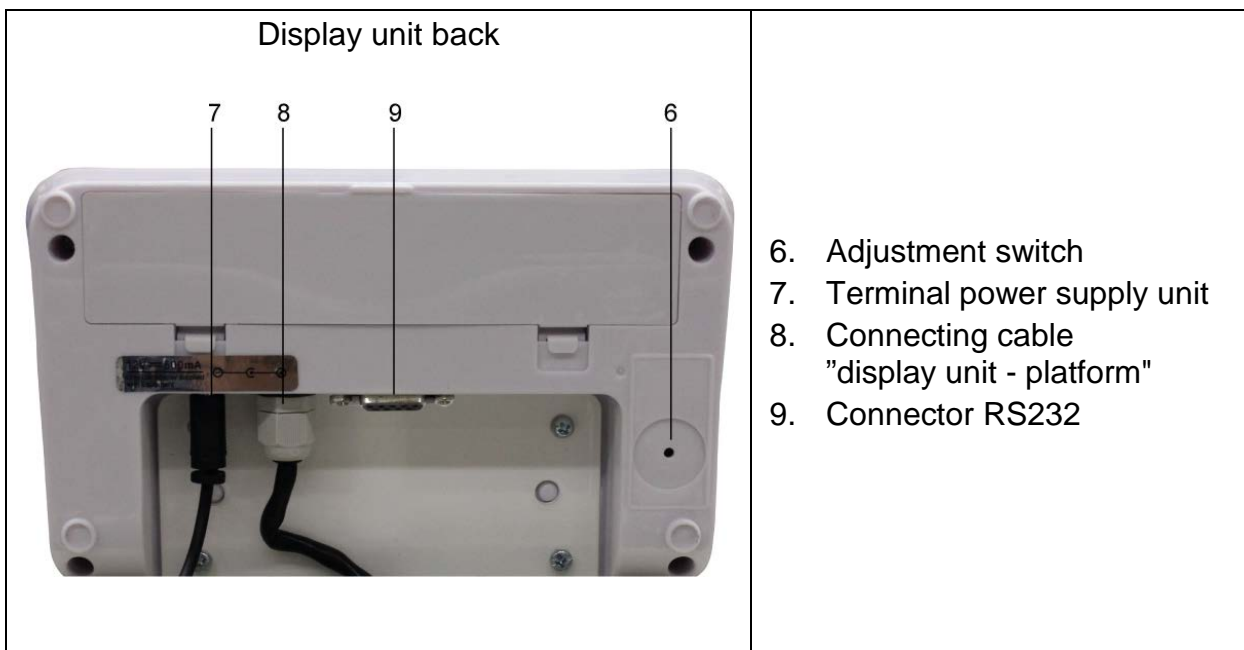
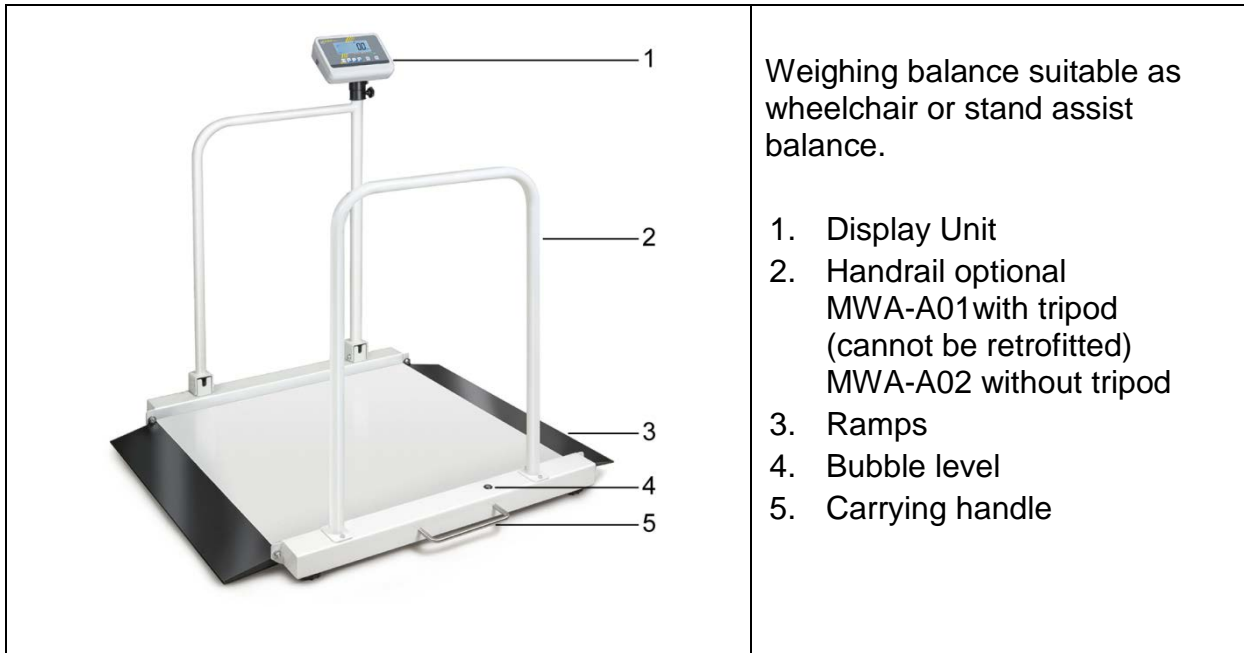

3 Appliance overview

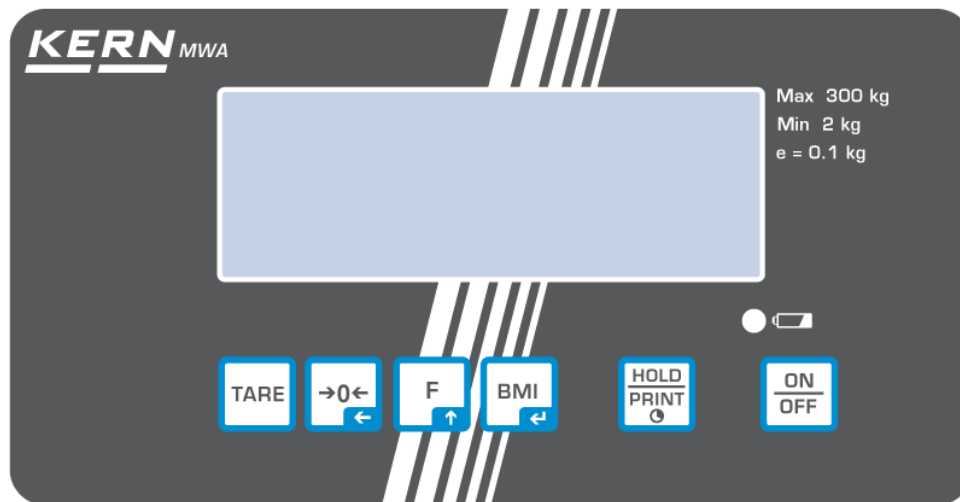
 <p>The wheelchair platform scale MWA-M with folded and unfolded ramps and the display (serial fitting).</p>	 <p>The wheelchair platform scale MWA-PM with folded and unfolded ramps, the display and the rail with a stand (serial fitting). The possibility of retrofitting with 2nd rail MWA-A02 (without a stand).</p>
	<p>Folded wheelchair platform scale MWA-PM.</p>









4 Keyboard overview



Button	Designation	Function
	ON/OFF button	Turn on/off
	Hold-key Print-key	Hold function /determination of stable weighing value Print (press and hold for a while): Data transmission via interface RS 232
	BMI key	Determination of body mass index In the menu: <ul style="list-style-type: none"> • Confirm selection For numeric entry: <ul style="list-style-type: none"> • Confirm numerical value
	Function key	In menu: <ul style="list-style-type: none"> • Call up menu • Select menu items For numeric entry: <ul style="list-style-type: none"> • Increase numerical value
	Zeroing key	Weighing scale will be reset to „0.0“ For numeric entry: <ul style="list-style-type: none"> • Change decimal place
	TARE key	Tare balance

5 Overview of display

Display	Designation	Description
	Stability display	Scales are in a steady state
	Zeroing display	Should the balance not display exactly zero despite empty weighing plate, press the  button. Your balance will be set to zero after a short standby time.
NET	Net weight display	Illuminated when net weight is displayed Illuminated after weighing scale was tared
GROSS	Gross weight display	Illuminated when gross weight is displayed
HOLD	HOLD function	HOLD function active
BMI	BMI function	Illuminated while BMI function is enabled
  	Rechargeable /Battery display	Shows the capacity of the rechargeable / batteries

6 Basic instructions



Weighing instruments have to be verified for the purposes stated below in accordance with Directive 2009/23/EC. Article 1, paragraph 4. "Determination of mass in the practice of medicine that is, weighing patients for reasons of medical supervision during medical surveillance, examination and treatment."

6.1 Specific function

- Indication**
- Determining the body weight in the medical practice area.
 - Use as „non-standalone weighing scale“, that is, a person steps carefully onto the weighing platform's centre. Once a steady display value is shown, you can read the weight value.
 - For weighing with a wheelchair, the wheelchair and the person sitting on it are pushed over the ramp onto the centre of the weighing platform or, in the case of an electric wheelchair, the patient and wheelchair move independently onto the weighing platform. Once a steady display value is shown, you can read the weight value.

- Contraindication**
- No contraindication known

6.2 Proper use

This weighing balance is designed for determining the weight of persons in a standing or sitting position in medical treatment rooms. The balance is suitable for recognising, preventing and controlling illnesses.

On multi-function balances, the weighed person should step onto the centre of the weighing platform and remain standing without moving. For weighing with a wheelchair, the wheelchair should be placed in the centre of the weighing platform.

As soon as a stable weighing value is reached the weighing value can be read. The weighing scale is designed for continuous duty.



The weighing platform may only be stepped on by persons capable of standing on both feet on the weighing platform.

The balance should be checked for correct condition prior to each utilisation by a person familiar with proper operation of the balance.

6.3 Improper Use

Do not use these scales for dynamic weighing processes.

Do not leave permanent load on the weighing pan. This may damage the measuring system.

Impacts and overloading exceeding the stated maximum load (max) of the weighing plate, minus a possibly existing tare load, must be strictly avoided. This could cause damage to the balance.

Never operate balance in explosive environment. The serial version is not explosion protected. It should be noted that a flammable mixture of anaesthetics and oxygen or laughing gas may occur.

The structure of the balance may not be modified. This may lead to incorrect weighing results, safety-related faults and destruction of the balance.

The balance may only be used according to the described conditions. Other areas of use must be released by KERN in writing.

6.4 Warranty

Warranty claims shall be voided in case

- Our conditions in the operation manual are ignored
- The appliance is used outside the described uses
- The appliance is modified or opened
- Mechanical damage and damage caused by media, liquids,
- Natural wear and tear
- The appliance is improperly set up or incorrectly electrically connected
- The measuring system is overloaded
- Dropping the balance

6.5 Monitoring of Test Resources

In the framework of quality assurance the measuring-related weighing properties of the balance and, if applicable, the testing weight, must be checked regularly. The responsible user must define a suitable interval as well as type and scope of this test. Information is available on KERN's home page (www.kern-sohn.com) with regard to the monitoring of balance test substances and the test weights required for this. In KERN's accredited DKD calibration laboratory test weights and balances may be calibrated (return to the national standard) fast and at moderate cost.

7 Basic Safety Precautions

7.1 Pay attention to the instructions in the Operation Manual



Carefully read this operation manual before setup and commissioning, even if you are already familiar with KERN balances.

7.2 Personnel training

The medical staff must apply and follow the operating instructions for proper use and care of the product.

7.3 Preventing contamination

The prevention of cross-contamination (fungal skin infections,.....) requires regular cleaning of the weighing platform. Recommendation: after a weighing procedure that could potentially result in contamination (e. g. after weighing that involves direct skin contact).

8 Electromagnetic compatibility (EMC)

8.1 General hints



The installation and use of the electrical multi-function balances MWA requires special precautionary measures as outlined in the EMC information below.

This device complies with the limits set for medical electrical devices of group 1, class B (as per EN 60601-1-2).

Electromagnetic compatibility (EMC) describes a device's ability to perform reliably within an electromagnetic environment without causing inadmissible electromagnetic interference at the same time. Amongst other things, such disturbances may be emitted by connecting cables or the air.

Inadmissible disturbances from the environment may result in incorrect displays, inaccurate measured values or incorrect behaviour of the multi-function balances MWA. The multi-function balances MWA, too, may in certain cases cause such malfunctions in other devices. To eliminate problems of that kind, we recommend you to take one or several of the measures listed below:

- Change the alignment or distance of the device to the source of failure.
- Install and use the multi-function balances MWA in one and the same place.
- Connect the multi-function balances MWA to a separate power source.
- For further questions please contact our customer services.

Disturbances may be caused by improper modification or add-ons to the device or not recommended accessories (such as power units or connecting cables). The manufacturer will not be responsible for these. Modifications may also result in a loss of authorisation relating to the use of the device.



Devices emitting high frequency signals (mobile telephones, radio transmitters, radio receivers) may cause interference in the multi-function balances MWA. Do not use these near multi-function balances MWA. Chapter 8.4 contains details about recommended minimum distances.

8.2 Electromagnetic interferences

Guidelines and manufacturer's declaration – electromagnetic interferences		
The multi-function balances MWA are intended for operation in the kind of electromagnetic environment stated below. The customer or user of the multi-function balances MWA should ensure that they are operated in this kind of environment.		
Emitted interference measurements	Conformity	Electromagnetic environment - guideline
HF emissions as per CISPR 11 / EN 55011	Assembly 1	The multi-function balances MWA apply HF energy exclusively for their internal function. Their HF emission therefore is very low and it is highly unlikely to interfere with adjacent electronic devices.
HF emissions as per CISPR 11 / EN 55011	Class B	The multi-function balances MWA are designed for use in all equipment including those in living areas and those connected directly to the public power grid that also supplies buildings used for living purposes.
Emission of harmonics acc. to IEC 61000-3-2	Class A	
Emission of voltage fluctuations / flicker acc. to IEC 61000-3-3	Conforms with	

Do not stack or operate multi-function balances MWA immediately next to or together with other devices. If this type of operation is necessary, observe the multi-function balances MWA to ensure normal operation in such an arrangement.

8.3 Electromagnetic noise immunity

Guidelines and manufacturer's declaration - electromagnetic noise immunity

The multi-function balances MWA are intended for operation in the kind of electromagnetic environment stated below. The customer or user of the multi-function balances MWA should ensure that they are operated in this kind of environment.

Noise immunity tests	IEC 60601 test level	Conformity	Electromagnetic environment - guideline
Discharge static electricity (DSE) acc. to IEC 61000-4-2	± 6 kV contact discharge ± 8 kV air discharge	± 6 kV ± 8 kV	Floors should be made of wood or concrete or tiled with ceramic tiles. If floors are covered with synthetic material, relative air humidity must be at least 30%.
Fast transient electrical disturbances / bursts acc. to IEC 61000-4-4	± 2 kV for power lines ± 1 kV for input and output lines	± 2 kV ± 1 kV	The quality of the supply voltage should match that of the typical business or hospital environment.
Impulse voltages / surges acc. to IEC 61000-4-5	± 1 kV voltage Live wire - live wire ± 2 kV voltage Live wire - earth	± 1 kV Inapplicable	The quality of the supply voltage should match that of the typical business or hospital environment.
Voltage dips, short-term disruptions and fluctuations in supply voltage acc. to IEC 61000-4-11	< 5 % U_T (> 95 % dip of U_T) for ½ period 40 % U_T (> 60 % dip of U_T) for 5 periods 70 % U_T (> 30 % dip of U_T) for 25 periods < 5 % U_T (> 95 % dip of U_T) for 5 s	Compliance with requirements under all postulated conditions Controlled switch off Return to undisturbed situation after user intervention.	The quality of the supply voltage should match that of the typical business or hospital environment. If the user demands continued functioning of multi-function balances MWA even after the occurrence of a power failure, we recommend using uninterruptible means of power supply or batteries for the multi-function balances MWA.
Magnetic field for supply frequency (50/60 Hz) acc. to IEC 61000-4-8	3 A/m	3 A/m 50/60 Hz	Magnetic fields for the supply frequency should match the typical values found in the particular business or hospital environment.

NOTE U_T equals AC line voltage prior to application of test level.

Guidelines and manufacturer's declaration - electromagnetic noise immunity

The multi-function balances MWA are intended for operation in the kind of electromagnetic environment stated below. The customer or user of the multi-function balances MWA should ensure that they are operated in this kind of environment.

Noise immunity tests	IEC 60601 test level	Conformity	Electromagnetic environment - guideline
Conducted HF disturbance variables acc. to IEC 61000-4-6	3 V_{rms} 150 kHz to 80 MHz	3 V	Do not use portable or mobile radio sets nearer to the multi-function balances MWA or their wires than the distance recommended as safety distance which is calculated according to the equation relevant for its transmission frequency.
Emitted HF disturbance variables Acc. to IEC 61000-4-3	3 V_{rms} 80 MHz to 2.5 GHz	3 V/m 	Recommended safety distance: $d = 1.2\sqrt{P}$ $d = 1.2\sqrt{P}$ for 80 MHz to 800 MHz $d = 2.3\sqrt{P}$ for 800 MHz up to 2.5 GHz Use P as rated capacity of radio transmitter in Watt (W) as per details given by the radio transmitter manufacturer and d as recommended safety distance in metres (m). The field intensity of stationary radio transmitters should for all frequencies be lower according to an in situ ^a examination than the conformity level. ^b Interference may occur near devices bearing the symbol below.

NOTE 1 Higher frequency range applies to 80 MHz and 800 MHz.
NOTE 2 These guidelines may not be applicable in all cases.
The spread of electromagnetic variables is influenced by absorption and reflections in buildings, objects and humans.

^a The field intensity of stationary radio transmitters such as base stations of wireless telephones and mobile radio sets, amateur radio stations, AM and FM radio and television stations cannot be reliably predicted in advance. To determine the electromagnetic environment in respect of stationary transmitters, you should consider a study of electromagnetic phenomena at the location. If the measured field intensity at the location where the balance is to be used exceeds the conformity level above, you should observe the multifunctional balances MWA in order to ensure normal operation. If you observe unusual features of performance you may have to take additional measures such as a change in alignment or a different location for the multifunctional balances MWA.

^b For a frequency range of 150 kHz to 80 MHz field intensity should be less than 3 V/m.

8.3.1 Crucial features of performance

Note:



The multifunctional balances MWA do not have any crucial features of performance as per IEC 60601-1. The system may be subject to interference by other devices even if these devices conform to current emission requirements as per CISPR.

8.4 Minimum distances

Recommended safety distance between portable and mobile HF telecommunication devices and multi-function balances MWA			
The multi-function balances MWA are designed for use in an electromagnetic environment in which HF disturbance variables are controlled. The customer or user of the multi-function balances MWA can help avoiding electromagnetic disturbances by keeping the minimum distance between portable and mobile HF telecommunication devices (transmitters) and the multi-function balances MWA – depending on the output performance of the communication device, as stated below.			
Rated capacity of transmitter W	The safety distance depends on the transmission frequency m		
	150 kHz up to 80 MHz $d = 1.2\sqrt{P}$	80 MHz up to 800 MHz $d = 1.2\sqrt{P}$	800 MHz up to 2.5 GHz $d = 2.3\sqrt{P}$
0.01	0.12	0.12	0.23
0.1	0.38	0.38	0.73
1	1.20	1.20	2.30
10	3.80	3.80	7.30
100	12.00	12.00	23.00
For transmitters with a maximum rated capacity not stated in the table above you can calculate the recommended safety distance in metres (m) yourself by using the equation belonging to each column, whereby P equals the maximum rated capacity of the transmitter in Watt (W) as per details provided by the transmitter manufacturer.			
NOTE 1	Higher frequency range applies to 80 MHz and 800 MHz.		
NOTE 2	These guidelines may not be applicable in all cases. The spread of electromagnetic variables is influenced by absorption and reflections in buildings, objects and humans.		

9 Transport and storage

9.1 Testing upon acceptance

When receiving the appliance, please check packaging immediately, and the appliance itself when unpacking for possible visible damage.

9.2 Packaging / return transport



- ⇒ Keep all parts of the original packaging for a possibly required return.
- ⇒ Only use original packaging for returning.
- ⇒ Prior to dispatch disconnect all cables and remove loose/mobile parts.
- ⇒ Reattach possibly supplied transport securing devices.
- ⇒ Secure all parts such as the weighing platform, power unit etc. against shifting and damage.

10 Unpacking, Setup and Commissioning

10.1 Installation Site, Location of Use

The balances are designed in a way that reliable weighing results are achieved in common conditions of use.

You will work accurately and fast, if you select the right location for your balance.

On the installation site observe the following:

- Place scales on a stable, even surface;
- Avoid extreme heat as well as temperature fluctuation caused by installing next to a radiator or in the direct sunlight;
- Protect the balance against direct draughts due to open windows and doors;
- Avoid jarring during weighing;
- Protect the balance against high humidity, vapours and dust;
- Do not expose the device to extreme dampness for longer periods of time. Non-permitted condensation (condensation of air humidity on the appliance) may occur if a cold appliance is taken to a considerably warmer environment. In this case, acclimatize the disconnected appliance for ca. 2 hours at room temperature.
- Avoid static charge of the balance and of the person to be weighed.
- Avoid contact with water.

Major display deviations (incorrect weighing results) may be experienced should electromagnetic fields (e.g. due to mobile phones or radio equipment), static electricity accumulations or instable power supply occur. Change location or remove source of interference.



10.2 Unpacking

Remove the individual components of the balance or the complete balance from the packaging with care and install at the intended location. When using the power pack, ensure that the power cable does not produce a risk of stumbling.

10.3 Scope of delivery

Serial accessories:

- Balance
- Mains adapter (in conformity with EN 60601-1)
- Operating manual
- Wall bracket
- Small components

	
4 x	2 x

10.4 Balance assembly and installation

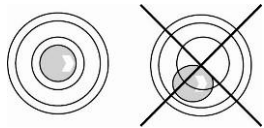



⇒ Level balance with foot screws until the air bubble of the water balance is in the prescribed circle.

⇒ Check levelling regularly.

The weighing balance to be used as wheelchair balance is delivered fully assembled. 1 handrail with tripod (MWA-A01) or 1 handrail without tripod (MWAS-A02) are optionally available for additional use as stand assist balance (See chap.3 device overview). The handrails are also suitable for use in connection with wheelchairs.

10.4.1 Application examples:

Weighing balance used as	
Wheelchair balance	stand assist balance with handrail MWS-A01
	

Assembly handrail MWA-A02 (optional):

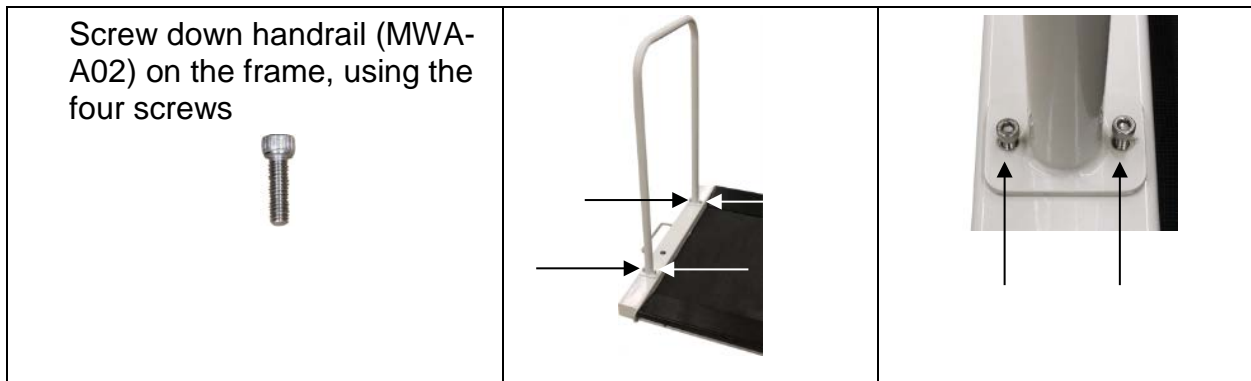

Note:

After fitting the attachments and before using the weighing balance, check all attachments for firm fit.

10.5 Mains connection

Power is supplied by the external power unit which also serves to isolate the mains supply from the scale. The stated voltage value must be the same as the local voltage.

Always use genuine approved KERN power pack units as per EN 60601-1 directive.

The small sticker attached to the side of the display unit indicates the power port:

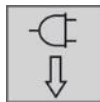

The LED remains illuminated as long as the weighing scale remains connected to the mains.

The LED display informs you during loading about the loading status of the rechargeable battery.

green: Rechargeable battery completely reloaded

blue: Charging storage battery

10.6 Battery operation is possible by obtaining an optional battery power pack



Open the battery compartment cover (1) at the base of the display unit and insert the rechargeable battery. Charge the battery for at least 12 hours before initial use.

The appearance of the symbol  in the weight display indicates that the battery is almost exhausted. The weighing scale will remain ready for operation for a few more minutes before switching off in order to save battery. Load rechargeable battery.

 Voltage has dropped below prescribed minimum.

 Rechargeable battery very low.

 Rechargeable battery completely reloaded

Right underneath the display there is a LED with the symbol .

If the LED lights green, the rechargeable battery is fully charged. If it is lighting blue, it is being charged.

If the balance is not used for a longer time, take out the rechargeable battery and store it separately. Leaking liquid could damage the balance.

10.7 Battery operation

As an alternative to rechargeable battery operation, the balance may also be operated with 6x AA batteries.

Open battery compartment cover (1) at the lower side of the display unit and insert batteries according to the example below. Lock the battery cover again. If the batteries are empty, in the balance display appears the symbol . Change batteries. To save battery power, the balance switches off automatically (see chap.11.6 Auto off).



Capacity of batteries exhausted.







Batteries will soon be flat.



Batteries are completely charged

Insert batteries

<p>Remove battery compartment cover</p>	
<p>Connect battery holder to housing contact acc. to illustration</p>	
<p>Insert battery holder</p>	
<p>Insert batteries into battery compartment and lock with battery compartment cover.</p>	

10.8 Initial Commissioning

In order to obtain exact results with the electronic balances, your balance must have reached the operating temperature (see warming up time chap. During this warming up time the balance must be connected to the power supply (mains, accumulator or battery) and be switched on.

The accuracy of the balance depends on the local acceleration of gravity.
The value of gravity acceleration is shown on the type plate.

11 Operation

11.1 Weighing

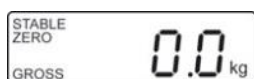

- ⇒ Start balance by pressing .
The balance will carry out a self-test
The scales are ready for operation as soon as the weight display for "0.0 kg" has appeared.



- However, you can reset the weighing scale to zero by pressing the  key.

- ⇒ Have person stand in the centre of the scales. Wait until the standstill display „STABLE“ appears, then read the weighing result.



- If the person is heavier than the weighing range, "OL" (=overload) will appear in the display.

11.1.1 Weighing with wheelchair

- ⇒ Place wheelchair and patient in the centre of the weighing balance.
- ⇒ Engage brakes on wheelchair



Do not leave the patient unattended

- ⇒ Wait until patient is sitting still and read weighing value 1.
- ⇒ Loosen the brakes and carefully pull off the transportation stretcher/wheelchair with patient
- ⇒ Then weigh the wheelchair without the patient and deduct the result from weighing value 1, from this follows the weight for the patient.

11.2 Taring

The tare weight of any preloads can be deducted by pressing a button so that the actual weight of the person is displayed in subsequent weighings.

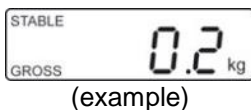

- ⇒ Put an object (such as a towel, support or empty wheelchair) on the weighing pan.

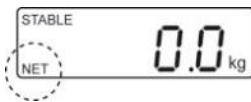

- ⇒ Press , the zero display appears. „NET” is shown at the bottom on the left.

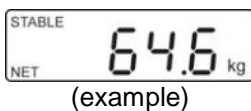

- ⇒ Allow the person to step onto the centre of the weighing platform. Wait until the standstill display „STABLE“ appears, then read the weighing result.



- When the balance is unloaded the saved taring value is displayed with negative sign.
- To delete the stored tare value, release scales and press 

11.3 HOLD function

The balance has an integrated standstill function (mean value calculation). With this function it is possible to weigh people accurately even if they do not stand still on the weighing plate.

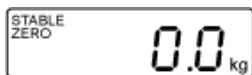

⇒ Start balance by pressing .
Wait for stability display „STABLE“ to appear.

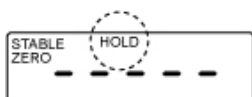

⇒ Press , in the display „-----“ will appear and the „HOLD“ symbol appears.

⇒ Allow the person to step onto the centre of the weighing platform.

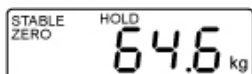

(example)

⇒ After a short time the stability display „STABLE“ appears and the weighing value of the person is displayed and „frozen“.

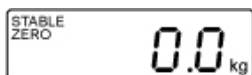

After unloading the balance, the weighing value remains displayed for approx. 10 seconds, than the balance changes automatically into the weighing mode.
The „HOLD“ symbol disappears.



There is no average value calculation in the event of too much movement.

11.4 Display additional last decimal place

(short-time, additional decimal place)

Press  and hold for about 2 s whilst weighed result is being shown. The second decimal place will be shown for approx. 5 s.

This value is not considered as verified and may not be used for the purpose of a verified balance.

11.5 Calculation of the Body Mass Index

You need to know a person's body height before you can calculate the BMI for that person. This should be known.

11.5.1 Calculating Body Mass Index

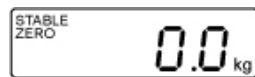

⇒ Start balance by pressing 

⇒ Wait for stability display „STABLE“ to appear.

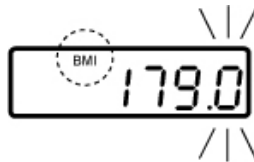

⇒ Press 

The most recently entered body height will be shown with the enable digit flashing. The BMI symbol lights up.

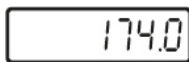

⇒ To enter body height, press the  and  key.

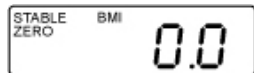

⇒ Confirm entered value by . BMI „0.0“ is displayed

⇒ Allow the person to step onto the centre of the weighing platform.



„-----“, is shortly displayed, followed by the BMI value of the person.

⇒ Unload weighing plate

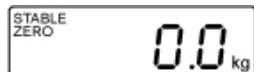

⇒ Return to weighing mode using 
The BMI symbol will disappear and the kg display will reappear.



- Reliable calculation of BMI is restricted to a body height of 100 cm to 200 cm and a weight of >10 kg.
- If weighing has to take place under unsteady conditions, you can be stabilise the display by applying the Hold function.

11.5.2 Classification of BMI values



Weight classification for adults over 18 years of age using the BMI in accordance with WHO, 2000 EK IV and WHO 2004.



Categorie	BMI (kg/m²)	Risk of diseases associated with overweight
Underweight	< 18.5	low
Normal weight	18.5 – 24.9	Average
Overweight	≥ 25.0	
Pre-adipose	25.0 – 29.9	A bit high
Adipose degree I	30.0 – 34.9	Increased
Adipose degree II	35.0 – 39.9	High
Adipose degree III	≥ 40	Very high

11.6 Automatic switch-off function „AUTO OFF“

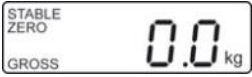

The weighing scale will switch off automatically after the allotted time as long as neither the display unit nor the weighing plate is operated.

i • Menu settings:
[F1 oFF] ⇒ **[oFF 0/3/5/15/30]** (see chap. 12)

 ⇒ In weighing mode, press  and the first function **[F1 oFF]** will be displayed.

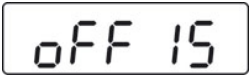

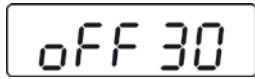
 ⇒ Press , the last saved time is displayed, for example, **[oFF 15]**

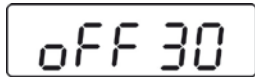

 (example)

 ⇒ Press  repeatedly until the desired time is displayed, e.g. **[oFF 30]**

 (example)

[oFF 0]	AUTO OFF - function disabled
[oFF 3]	Weighing system will be turned off after 3 min.
[oFF 5]	Weighing system will be turned off after 5 min.
[oFF 15]	Weighing system will be turned off after 15 min.
[oFF 30]	Weighing system will be turned off after 30 min.

 ⇒ Save selected time with , **[F1 oFF]** is displayed

 ⇒ Return to weighing mode using 

11.7 Display background illumination



- Menu settings:
[F2 bk] ⇒ [bL on / bL oFF / bL AU] see chap. (12)

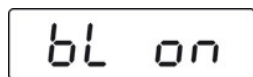
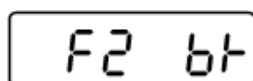

(example)



⇒ In weighing mode, press and the first function [F1 oFF] will be displayed.

⇒ Press until [F2 bk] is displayed.

⇒ Press , the last saved setting is displayed, for example [bL on]

⇒ To select the desired setting, press

bL on	Continuous background lighting
bL off	Background illumination off
bL Auto	Automatic background illumination on when weighing pate is loaded or key pressed.

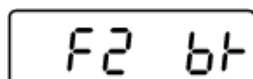

⇒ With save select setting , [F2 bk] is displayed.



⇒ Return to weighing mode using

12 Menu









Access to service menu „tCH“ is locked in verified balances.
To disable the access lock, destroy the seal and actuate the adjustment switch. For position of adjustment switch, see chap. 17.





Attention:





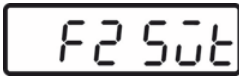
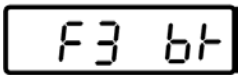
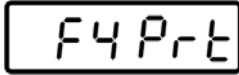



After destruction of the seal the weighing system must be re-verified by an authorised agency and a new verification wire/seal mark fitted before it can be reused for applications subject to verification.

12.1 Navigation in the menu

<p>Call up menu</p>	<p>⇒ In weighing mode, press  and the first function [F1 oFF] will be displayed.</p>
<p>Select function</p>	<p>⇒ With help of , the individual functions can be selected one after the other.</p>
<p>Change settings</p>	<p>⇒ Confirm selected function by . The current setting will be displayed.</p> <p>⇒ Select desired setting by  and confirm with , the balance returns to the menu.</p>
<p>Exit menu/ Return to weighing mode</p>	<p>⇒ Press , the balance will return to weighing mode.</p>

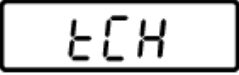
12.2 Menu overview

Function	Settings	Description
 Automatic cutout Auto Off	oFF 0*	Automatic shutdown off
	oFF 3	Automatic shutdown after 3 min.
	oFF 5	Automatic shutdown after 5 min.
	oFF 15	Automatic shutdown after 15 min.
	oFF 30	Automatic shutdown after 30 min.
 Background illumination of display	oFF*	Not documented
	Prt	
	Pr ACC	
 Background illumination of display	bl on	Back lighting for display on
	bl oFF	Display background illumination off
	bl AU*	Backlighting for display will come on automatically as soon as the weighing scale is operated.
 Interface parameter	1. RS-232 mode Select desired mode by  , then confirm with  .	
	P Prt	Weight will be added to summation memory and printed after pressing PRINT
	P Cont	Continuous data output
	Series	Not documented
	ASK	Remote control instructions: W: Send all weighing details S: Send stable weight value T: Taring Z: Zeroing
	P cnt 2	Not documented
	P Stab	Automatic data output of stable weighing values
	P Auto	Weighed result will be added automatically to summation memory and issued
	2. Baud rate The currently set baud rate (b xxx) will be shown after the RS-232 mode was confirmed. Select desired Baudrate by pressing  and confirm by pressing  . Available Baud rate: 600, 1200, 2400, 4800, 9600	

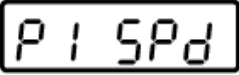
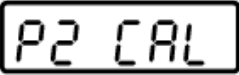
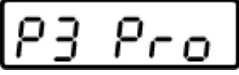
<p>3. Data output format (Setting P Prt, P Auto, P Cont only!) The currently set data output format will be displayed after the Baud rate has been confirmed. Select desired format by  and confirm with .</p>									
only at setting P Prt, P	<table border="1"> <tr> <td>Prt 0-3</td> <td>Data output format, see chap. 13</td> </tr> </table>	Prt 0-3	Data output format, see chap. 13						
Prt 0-3	Data output format, see chap. 13								
Only when set P Cont	<table border="1"> <tr> <td>Cont 1</td> <td>Default</td> <td rowspan="3">Sd0 – on/off Continuous data output, selectable “Sending 0” yes / no</td> </tr> <tr> <td>Cont 2</td> <td>Not documented</td> </tr> <tr> <td>Cont 3</td> <td>Not documented</td> </tr> </table>	Cont 1	Default	Sd0 – on/off Continuous data output, selectable “Sending 0” yes / no	Cont 2	Not documented	Cont 3	Not documented	
Cont 1	Default	Sd0 – on/off Continuous data output, selectable “Sending 0” yes / no							
Cont 2	Not documented								
Cont 3	Not documented								
<p>4. Printer type The currently set printer type will be displayed after the data output format has been confirmed. Select desired printer type by pressing  and confirm with .</p> <table border="1"> <tr> <td>LP 50</td> <td>Not documented</td> </tr> <tr> <td>tPUP</td> <td>Use this setting</td> </tr> </table>		LP 50	Not documented	tPUP	Use this setting				
LP 50	Not documented								
tPUP	Use this setting								
 Service menu	Pin Password Input: press  ,  ,  subsequently. Operate adjustment switch; for position see chap.15								
 Display speed	<table border="1"> <tr> <td>15*</td> <td rowspan="4">Not documented</td> </tr> <tr> <td>30</td> </tr> <tr> <td>60</td> </tr> <tr> <td>7.5</td> </tr> </table>	15*	Not documented	30	60	7.5			
15*	Not documented								
30									
60									
7.5									
	Adjustment, see chap. 18								
	<table border="1"> <tr> <td>tri*</td> <td>Not documented</td> </tr> <tr> <td>CoUnt</td> <td>Not documented</td> </tr> <tr> <td>rESEt</td> <td>Reset weighing scale to factory setting</td> </tr> <tr> <td>SEtGrA</td> <td>Not documented</td> </tr> </table>	tri*	Not documented	CoUnt	Not documented	rESEt	Reset weighing scale to factory setting	SEtGrA	Not documented
tri*	Not documented								
CoUnt	Not documented								
rESEt	Reset weighing scale to factory setting								
SEtGrA	Not documented								

13 Data output RS 232

You can print weighing data automatically via the RS 232 interface or manually by pressing  via the interface according to the setting in the menu.

This data exchange is asynchronous using ASCII - Code.

The following conditions must be met to provide successful communication between the weighing balance and the printer.

- Use a suitable cable to connect the weighing balance to the interface of the printer. Faultless operation requires an adequate KERN interface cable.
- Communication parameters (baud rate, bits and parity) of balance and printer must match. For detailed description of interface parameters see chap. 13.2)

13.1 Pin allocation of balance output bushing:

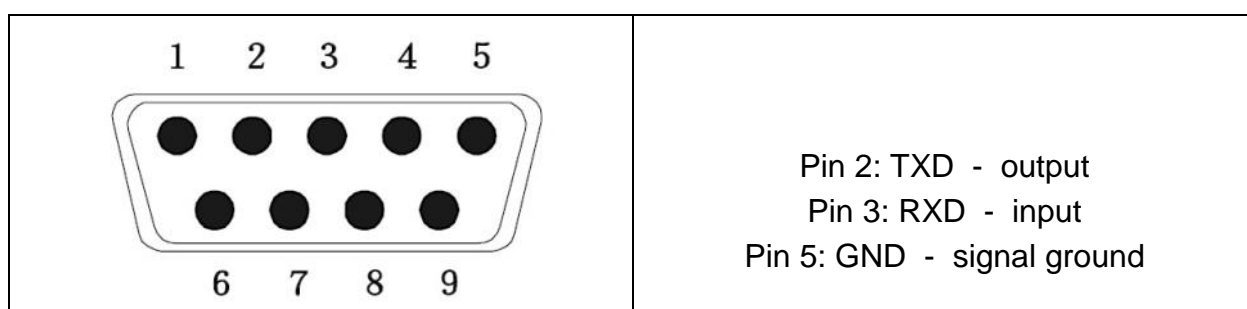

13.2 Technical data

Connection	9 pin d-subminiature bushing Pin 2 output Pin 3 input Pin 5 signal earth
Baud rate	Optional 600/1200/2400/4800/9600
Parity	8 bits

13.3 Printer operation

Printout examples:

Prt	
0 / 2	60.0kg
1 / 3	60.0kg 170.0cm 20.7BMI

14 Error messages

Display

Description

Err4

Zero range exceeded

(on start-up or when pressing the  key)

- Load on weighing pan
- Excess load, during zero setting of weighing scale
- Incorrect adjusting process
- Fault on load cell

Err6

Value outside the A/D converter range

- Damaged weighing cell
- Damaged electronics

Should other error messages occur, switch balance off and then on again. If the error message remains inform manufacturer.

15 Servicing, maintenance, disposal

15.1 Cleaning



Before any maintenance, cleaning and repair work disconnect the appliance from the operating voltage.

15.2 Cleaning / disinfecting

Clean weighing platform (such as seat) as well as casing with household detergents or commercially available disinfectants. Please follow manufacturer's instructions.

Do not use abrasive or aggressive cleaners such as spirits or alcohol or similar as they might damage the high-quality surface.

The prevention of cross-contamination (fungal skin infections,.....) requires regular cleaning of the weighing platform. Recommendation: after a weighing procedure that could potentially result in contamination (e. g. after weighing that involves direct skin contact).



Do not spray disinfectants onto appliance.

Make sure that disinfectant does not penetrate the interior of the appliance.

Remove dirt immediately.

15.3 Servicing, maintenance

The appliance may only be opened by trained service technicians who are authorized by KERN.

Disconnect the scales before opening.

15.4 Disposal

Disposal of packaging and appliance must be carried out by operator according to valid national or regional law of the location where the appliance is used.

16 Instant help

In case of an error in the program process, briefly turn off the balance and disconnect from power supply. The weighing process must then be restarted from the beginning.

Fault

Possible cause

The displayed weight does not glow.

- The balance is not switched on.
- The mains supply connection has been interrupted (mains cable not plugged in/faulty).
- Power supply interrupted.
- Rechargeable battery inserted incorrectly or empty
- No rechargeable battery inserted

The displayed weight is permanently changing

- Draught/air movement
- Table/floor vibrations
- The weighing plate is in contact with foreign bodies or is not correctly positioned.
- Electromagnetic fields / static charging (choose different location/switch off interfering device if possible)

The weighing result is obviously incorrect

- The display of the balance is not at zero
- Adjustment is no longer correct.
- Great fluctuations in temperature.
- Warm-up time was ignored.
- Electromagnetic fields / static charging (choose different location/switch off interfering device if possible)

Should other error messages occur, switch balance off and then on again. If the error message remains inform manufacturer.

17 Verification

General introduction:

According to EU directive 2009/23/EC balances must be officially verified if they are used as follows (legally controlled area):

- a) For commercial transactions if the price of goods is determined by weighing.
- b) For the production of medicines in pharmacies as well as for analyses in the medical and pharmaceutical laboratory.
- c) For official purposes
- d) For manufacturing final packages

In cases of doubt, please contact your local trade in standard.

Verification notes:

An EU type approval exists for balances described in their technical data as verifiable. If a balance is used where obligation to verify exists as described above, it must be verified and re-verified at regular intervals.

Re-verification of a balance is carried out according to the respective national regulations. For verification validity period, s. chap. 17.1.

The legal regulation of the country where the balance is used must be observed!



Verification of the balance is invalid without the seal.

The seal marks attached on balances with type approval point out that the balance may only be opened and serviced by trained and authorised specialist staff. If the seal mark is destroyed, verification loses its validity. Please observe all national laws and legal regulations. In Germany a re-verification will be necessary.

Balances with obligation to verify must be taken out of operation if:

- **The weighing result of the balance is outside the error limit.** Therefore, in regular intervals load balance with known test weight (ca. 1/3 of the max. load) and compare with displayed value.
- **The reverification deadline has been exceeded.**

Position adjustment switch and seals

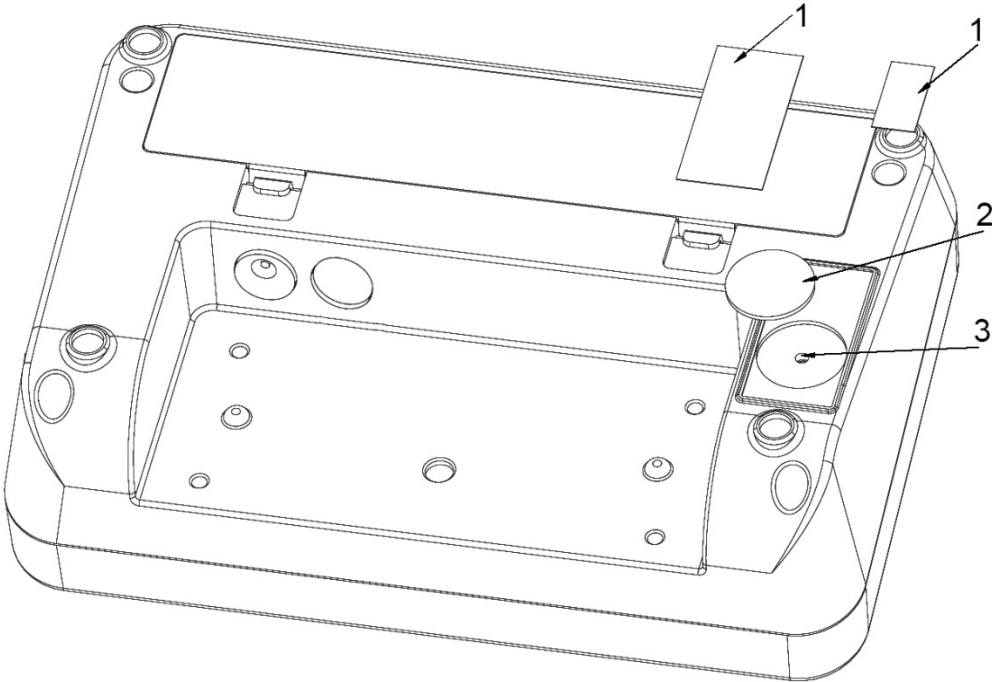

- 1. Self-destroying seal mark
- 2. Cover
- 3. Adjustment switch

17.1 Verification validity period (current status in G)

Multi-function balances (including chair and wheelchair scales) in hospitals	4 years
Multi-function balances, when not located in hospitals (for example, doctor's offices and nursing homes)	unlimited
Baby weighing scales and mechanical birth weight scales	4 years
Bed scales	2 years
Scales in dialysis stations	unlimited

Rehab clinics and health authorities are treated as hospitals (4 years of verification validity)

Not treated as hospitals (verification validity not limited) are dialysis stations, nursing homes and doctor's surgeries.

(Data source : "Bureau of Standards News, Weighing Instruments in Medicine")







18 Adjustment







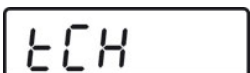









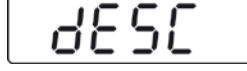

As the acceleration value due to gravity is not the same at every location on earth, each display unit with connected weighing plate must be coordinated - in compliance with the underlying physical weighing principle - to the existing acceleration due to gravity at its place of location (only if the weighing system has not already been adjusted to the location in the factory). This adjustment process must be carried out for the first commissioning, after each change of location as well as in case of fluctuating environment temperature. To receive accurate measuring values it is also recommended to adjust the display unit periodically in weighing operation.

	<ul style="list-style-type: none"> • Prepare the required adjustment weight. The adjustment weight to be applied depends on the capacity of a weighing scale, see chap. 1. Carry out adjustment as closely as possible to admissible maximum load of weighing scale. Info about test weights can be found on the Internet at: http://www.kern-sohn.com. • Observe stable environmental conditions. For warm-up time required for stabilisation see chap. 1.
---	--

	<p>Access to service menu „tCH“ is locked in verified balances.</p> <p>To disable the access lock, destroy the seal and actuate the adjustment switch. Position of the adjustment switch see chap. 17.</p> <p>Attention: After destruction of the seal the weighing system must be re-verified by an authorised agency and a new verification wire/seal mark fitted before it can be reused for applications subject to verification.</p>
---	--

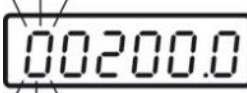
Procedure:

  	<p>⇒ In weighing mode, press  repeatedly until [tCH] appears.</p>
	<p>⇒ Press , [Pin] is displayed</p>

	Press  ,  and  one after the other, [P1 SPd] will appear
  	⇒ Press  , „ P2 CAL “ will be displayed ⇒ Operate adjustment switch; for position see chap.16
	⇒ Press  , [dESC] is displayed
	⇒ Press  repeatedly until [CAL] will be displayed. ⇒ Confirm with  , [UnloAd] appears
	⇒ Ensure that there are no objects on the weighing pan. ⇒ Wait for stability display "STABLE", then confirm with 
 (example)	⇒ The size of the currently set adjustment weight will be displayed. To change, select the digit to be altered by  , and the numerical value by  . ⇒ Confirm with  , [LoAd] appears.

	<ul style="list-style-type: none"> ⇒ Place adjustment weight in the centre of the weighing pan ⇒ Wait until stability display „STABLE“ appears
<p style="text-align: center;">↓</p>	<ul style="list-style-type: none"> ⇒ Confirm with  [PASS] is displayed. ⇒ The balance carries out a selftest, after that [Err19] will be displayed and a signal will sound.
	<ul style="list-style-type: none"> ⇒ Switch off the balance ⇒ Take away adjustment weight ⇒ Turn on balance again, after the selftest the balance changes into the weighing mode. Adjustment has now been completed successfully.